



maia[®]

innovation in worksurface technology



maia...designed for living

maia designer worksurfaces are both stylish and durable, representing a truly innovative solid surface alternative to the high cost and inherent drawbacks of natural stone.

With six new colours inspired by the very latest in kitchen designs, all **maia** work surfaces are heat resistant, impenetrable to dust, dirt and bacteria and are very easy to clean. Available in a variety of modular options, there is no limit to the flexibility of **maia**'s comprehensive worksurface range.

A silky smooth finish and seamless joints make **maia**'s worksurfaces a luxurious addition to your home. Supplied in a wide range of décors to suit every design, coupled with a 10 year manufacturer's warranty, **maia**'s worksurface solution is at the forefront of the UK market.



maia...See our **NEW** range of acrylic undermount sinks on page 8



A	B	C

A. maia 28mm Sandstone worksurface
 B. maia Galaxy worksurface
 C. maia Calcite worksurface





maia...stylish and durable
the complete solution for your solid surface needs

The **maia** range comprises a new 28mm thick worksurface, as well as the existing and very popular 42mm and 54mm thicknesses. Available with square or curved corners, **maia** gives you flexibility and choice to include in your unique kitchen design.

maia is also designed to make fitting your worksurface as quick and easy as possible. All surfaces are completely factory finished and we've now added 3.6m long sink modules to reduce the number of joints that you may need.

The innovation doesn't stop there. Our acrylic undermount sink modules are fully factory fitted with smooth flowing lines for the most luxurious of finishes.



A	B	C
---	---	---

A. maia 42mm Calcite worksurface with matching 150mm upstand
B. maia 54mm Iceberg worksurface with designer sink module
C. maia 42mm Calcite worksurface with designer sink module



A	B	C
---	---	---

A. maia Cristallo worksurface with 1.5 sink module
 B. maia Vanilla worksurface, soft to the touch and hygienic too
 C. maia Galaxy worksurface with super large sink module



maia*...easy fit installation

The **maia*** easy to fit system makes installation simple, and allows you to create worksurfaces to fit your own design requirements.

Surfaces can be readily installed using standard wood working equipment and they are supplied pre-edged*. All this means that there is no need for expensive and time consuming templating usually associated with solid surface products. *see diagrams on page 22/23 for full details.

Jointing and edging made easy

Jointing kit instructions and easy to apply edging make **maia** easy to install. Our unique jointing system can be used by kitchen fitters with conventional woodworking tools to achieve the seamless joint and edge for the complete 'solid look'.

Installation, care and maintenance manual

maia's installation, care and maintenance manual provides all the information needed to fit and care for your **maia** worksurface. Manuals are supplied, free of charge, to every customer upon purchasing a **maia** worksurface, and include instructions on cutting, jointing and edging, as well as fitting upstands, splashbacks, décor panels and sink modules.

The manual features a comprehensive guide to general cleaning and stain removal, plus full warranty information. All elements of the manual are covered in the **maia** installation DVD.

Works Service

Sometimes you need out of the ordinary worktops specially configured for your kitchen plan. Our Works Service offers you factory manufactured bespoke worktop designs delivered to your door.



maia...sink modules

maia has a range of undermounted sink modules which are sold as part of a specially fabricated 1.8m or 3.6m worktop with the sink area centrally positioned.

Our sink modules come complete with either **maia** brushed stainless steel sinks or white acrylic bowls. Our sinks have an attractive 25mm radius to the corners and each is also supplied with the necessary waste fittings and pipework - all you have to do is add the tap.

The new acrylic undermount bowls are factory fitted to the module to give a beautiful, flowing, seamless finish to your sink.

Whichever option you choose, your **maia** undermount sink will bring a bespoke feel to your kitchen and be as practical as it is good looking.



A	B	
	C	D

A. Designer 1.5 bowl in maia Iceberg
 B. 1.5 bowl sink module in maia Vulcano
 C. maia Ammonite acrylic sink module
 D. maia Fossil with acrylic undermount bowl

maia®...sink modules, it's your choice



single bowl

maia's single bowl...600mm deep, edged front and back, reversible left or right handed. Pre drilled for tap and pop-up waste. Will fit into 500mm base cabinet. Includes brushed stainless steel bowl, pop-up waste, fitting clips and sealant.

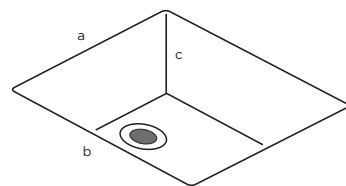

single bowl

- a. 340mm
- b. 400mm
- c. 190mm



super large bowl

maia's super large bowl...600mm deep, edged front and back, reversible left or right handed. Pre drilled for tap and pop-up waste. Will fit into 600mm base cabinet. Includes brushed stainless steel bowl, pop-up waste, fitting clips and sealant.

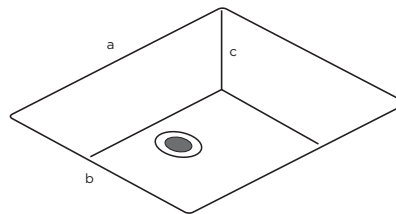

super large bowl

- a. 480mm
- b. 400mm
- c. 200mm



1.5 bowl duo

maia's 1.5 bowl...600mm deep, edged front and back, reversible left or right handed. Pre drilled for tap and pop-up waste. Will fit into 600mm base cabinet. Includes brushed stainless steel main bowl and separate small bowl, basket strainer, pop-up waste, fitting clips and sealant.

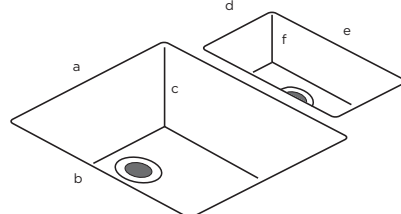

1.5 bowl

- a. 340mm
- b. 400mm
- c. 190mm
- d. 160mm
- e. 300mm
- f. 120mm



1.5 designer bowl

maia's 1.5 designer bowl...650mm deep, edged front, left or right bowl options. Pre-drilled for tap. Will fit into 600mm base cabinet. Includes combined 1.5 bowl brushed stainless steel sink, basket strainers, fitting clips and sealant.

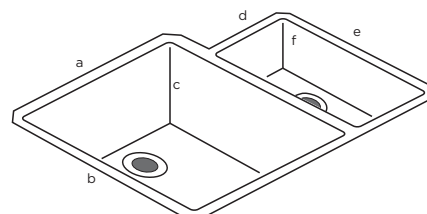

1.5 designer bowl

- a. 340mm
- b. 400mm
- c. 190mm
- d. 160mm
- e. 300mm
- f. 120mm



single bowl acrylic

maia's single bowl acrylic...650mm deep, edged front, left or right bowl options. Pre-drilled for tap. Will fit into 600mm base cabinet. Includes factory fitted single bowl acrylic sink and pop-up waste.

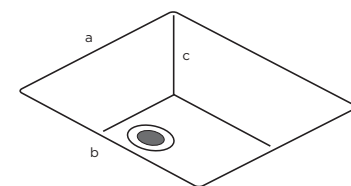

single bowl acrylic

- a. 340mm
- b. 400mm
- c. 190mm



super large bowl acrylic

maia's super large bowl acrylic...650mm deep, edged front, left or right bowl options. Pre-drilled for tap. Will fit into 600mm base cabinet. Includes factory fitted single bowl acrylic sink and pop-up waste.

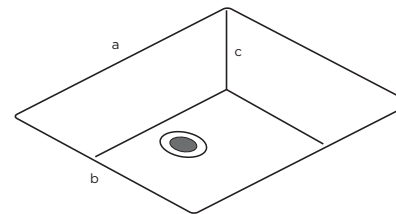

super large bowl acrylic

- a. 480mm
- b. 400mm
- c. 190mm



1.5 bowl duo acrylic

maia's 1.5 duo bowl acrylic...650mm deep, edged front, left or right bowl options. Pre-drilled for tap. Will fit into base cabinet openings over 650mm. Includes factory fitted 1.5 bowl acrylic sink, basket strainer, pop-up waste.

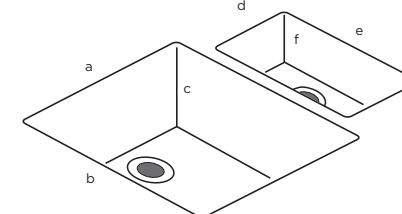

1.5 bowl acrylic

- a. 340mm
- b. 400mm
- c. 190mm
- d. 160mm
- e. 300mm
- f. 120mm



1.5 designer bowl acrylic

maia's 1.5 designer bowl acrylic...650mm deep, edged front, left or right bowl options. Pre-drilled for tap. Will fit into base cabinet openings over 650mm. Includes factory fitted combined 1.5 bowl acrylic sink and basket strainers.

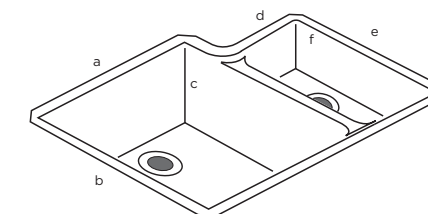

1.5 designer bowl acrylic

- a. 340mm
- b. 400mm
- c. 190mm
- d. 160mm
- e. 300mm
- f. 120mm

All maia® sink modules are available in 28, 42 and 54mm thicknesses - in either 1800 or 3600mm lengths and are supplied as either left or right hand bowl which must be specified at the time of order. Images shown are right hand bowl.

Both stainless steel and acrylic bowls are suitable for use with waste disposal units. Only stainless steel bowls are suitable for use with instant hot water taps. Allowing instant hot water taps to run freely into acrylic bowls over a period of time may result in superficial crazing of the acrylic surface.



A	B	E	F
C	D		

A. Hot rods offer a convenient protection for your worktop surface
 B. Matching upstands complement your worktop surface
 C. Co-ordinating plinth and 70mm upstand in maia Cristallo
 D. A maia chopping board is a co-ordinated way to look after your worktop surface
 E. maia Mocha worktop with full splashback and 100mm decorative support panel
 F. maia Cristallo hob splashback with matching 150mm upstand



maia*...finishing touches

The **maia*** range includes a collection of accessories and finishing touches to help create the perfect kitchen. In addition to the products featured here, **maia*** offers a full range of installation materials and accessories see page 22/23 for more details.

maia*'s finishing touches include:

Splashback...for a contemporary, streamlined look in your kitchen simply add a splashback instead of tiling.

Taps...specially selected taps to complement the rest of the **maia*** range. Contour, Curve, Geometry, Mix and Flow are high specification taps whose performance matches their excellent looks.

Hob splashback...for the hardworking area behind the hob or for smaller applications this compact sheet could be the perfect solution.

Upstand...an upstand creates a simple, clean look in your kitchen and is easily combined with splashbacks where used.

Decorative support panels...available in all décors with either 45mm or 100mm depth. These help to create a framed look to your kitchen or are perfect for breakfast bar supports.

Plinth...co-ordinating plinths are available to complete the look.

Hot rods...a set of six stainless steel effect worktop protector rods with self-adhesive backing for simple fitting.

Chopping board...maia*'s chopping boards are available to blend in or contrast with your worktop surface.



A. maia Vanilla worksurface and island unit
 B. maia Meteorite worksurface with matching 150mm upstand



Ammonite

Ammonite is a dark grey with silver and brown metallic particles. Developed to look stunning with contemporary white and grey kitchens, and also a modern twist on a more traditional look to work with light and medium oaks.



Calcite

Delivering a fresher look than Vanilla, Calcite contains light grey particles suspended in a creamy white background. Works well with light and medium oaks as well as black. A youthful take on a traditional classic.



Fossil

Particles of silver and pearl combine in Fossil to bring a stunning new colour that will work with the majority of kitchen colours and designs.



Meteorite

Gorgeous browns and olives combine with copper metallic particles to deliver luxurious warmth. Not as stark as black, Meteorite works well with cream, white and light coloured woods.



Pearlstone

Bright and crisp with the look of stone, Pearlstone is a pearl white colour with clear granular particles. Works well with truffle, taupe, blacks and browns.



Sandstone

Bringing natural warmth, Sandstone will complement both light and dark coloured kitchens.



Cappuccino

Cappuccino is a stylish choice to complement woods and plain doors. Add dark doors, cream and brown for a relaxed feel, or vibrant zebano doors to make an impact.



Cristallo

Cristallo is a crisp, solid white with contrasting grey granules. Perfect with silver doors for a modern, industrial feel, or with walnut for classic style.



Galaxy

Galaxy's metallic flecks bring sparkle to your worktop - metallic particles catch the light and complement the deep black background.



Iceberg

Iceberg's beauty lies in its purity. White has become a strong trend for worksurfaces - team with matching doors for a simple, calm style, or with splashes of colour to make a statement.



Latte

Latte is another 'natural neutral' in the maia range. Lighter than Mocha but with deeper tones than maia's original coffee décor, Cappuccino, Latte has quickly become a popular choice.



Lava

Lava is grey with small speckles of brown to create a natural stone effect. Stunning in a blue kitchen with glass, wood and white accessories, or stylishly industrial with glossy black or metallic doors.



Mocha

Mocha brings a deep brown to the maia range. As neutral door colours such as latte and cream grow in popularity, so Mocha really comes into its own.



Vanilla

Vanilla is an elegant colour which complements many kitchen designs. Its coloured flecks make it the perfect match for a range of door colours. Contrast with black for added drama.



Vulcano

Vulcano is the most popular colour in the maia range. Its sophisticated black background is interspersed with contrasting white flecks and subtle hints of yellow.

maia®...colour palette

	B	
A	C	

A. maia Ammonite acrylic sink module
 B. maia Lava worksurface
 C. maia Latte worksurface and 100mm decorative support panel



maia®...Works Service

sometimes you need out of the ordinary worktops specially configured for your kitchen plan

For some time now the **maia®** range has delivered high quality worktop solutions but on occasions the standard **maia** products do not cover everyone's requirements. **maia's** 'Works Service' offers you access to **maia** products specially configured for your kitchen design drawing using a combination of hi tech machinery and hand finishing. Ask your kitchen designer for more details.

Example products...



3.6m x 1.2m worktop sink module

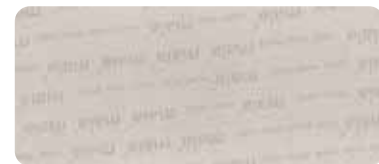

2.7m x 1.2m worktop curved at 4 corners

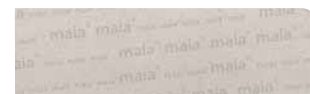

2.2m x 650mm peninsular worktop

A	B	C

A. Hand finished by our specialists
 B. maia Meteorite curved worktop
 C. maia Calcite peninsular worktop with maia Meteorite bespoke table



maia®
 Works Service



maia...creative freedom and durability

maia® products are all factory edged and finished with crisp, square edges.

In addition to the standard range, maia also offers worktops with a curve at each end and breakfast bar islands with a curve at all corners. These curved products have radiused ends to match the growing trend for curved kitchen doors to create a softer look. The 240mm radius on maia's curved products complements the majority of new style kitchen doors.

maia's 54mm worksurface specification is perfect if you're looking for a chunkier style whilst for a sleek look the 28mm thickness offers a different effect altogether. These options also follow the modular concept, just like the original 42mm size, making kitchens simple to plan and design.

28mm, 42mm & 54mm worktops are available in all décors and sizes, and with any of the sink modules in the maia range.

	B	D
A	C	

A. maia Cappuccino internal curve - a Works Service option
 B. Curved breakfast bar island in maia Cristallo
 C. Breakfast bar island unit in maia Cappuccino
 D. Curved unit in maia Calcite

maia*...designed for living, designed for life!

maia* solid surfaces come with a ten-year guarantee*, and are supported by the FIRA Gold Award for product excellence – this is testimony to the fact we only use the most superior materials, and our products are constantly tested to ensure they are manufactured to the highest possible standards. *Guarantee covers manufacturing, not installation.

maia has been developed to be used in the domestic environment – particularly the kitchen. Although no ‘special’ maintenance is needed we recommend the following is adhered to, as prevention is always better than cure.

Routine cleaning

maia does not require any specialist cleaning regimes - most dirt and light residue will easily wipe away with a damp cloth and soapy water. The worksurface should then be rinsed with clean water and wiped dry. Persistent marks can be removed by using a mild-abrasive cleaner, but harsh scouring powders should be avoided. If in doubt, consult our care and maintenance guide.

Heat

maia's surfaces will withstand heat better than many alternative surface materials. However, all hot pots, pans and other heat generating devices should always be placed upon a trivet or worktop protector rods, to prevent extreme heat having prolonged and direct contact with the surface. Boiling water and cooking splashes do not harm the surface.

Staining

maia, unlike marble and granite, will resist most household chemicals including alcohol and cosmetics however, some chemicals and strong dyes can cause damage and discolouration. If spillage occurs wipe off immediately and rinse area thoroughly.

Minor scratching

Kitchen utensils and crockery (particularly the unglazed bases) can sometimes cause scratches that will be particularly evident on darker colours. The surface can be damaged by scratching or cutting with knives, so the use of a cutting board is essential. Don't worry though, any minor scratches can easily be removed using a red abrasive pad and other items from the Care Kit. Please refer to the care and maintenance guide.

maia Care Kit

To help maintain your **maia** worksurface, a Care Kit is available from your retailer. This kit contains all that you need to make minor repairs to the surface and a special cleaner that helps to maintain, protect and build up a lustre particularly on darker colours.



Our commitment to customer service

When you choose **maia** you can be safe in the knowledge that you are getting a proven, reliable product; a product that is truly at the forefront of worksurface technology.

Our customer care department is on hand to offer you help, support and advice all year round call **01773 521 300**.

Quality assured

- ✓ Barcol Hardness - EN59
- ✓ Light Fastness - ISO 4892
- ✓ Fungal Resistance - EN ISO 846
- ✓ Food Safety - EN V 1186
- ✓ Bacterial Resistance - EN ISO 846
- ✓ Exposure to Dry Heat - EN 438-2.8



maia*...specifications

maia* worktops are designed for living and also designed to make planning and installation as straightforward as possible. To do this, all surfaces are pre-finished to save time on site and we factory fit edging as shown in the following diagrams.

|| factory applied edging — unfinished edges

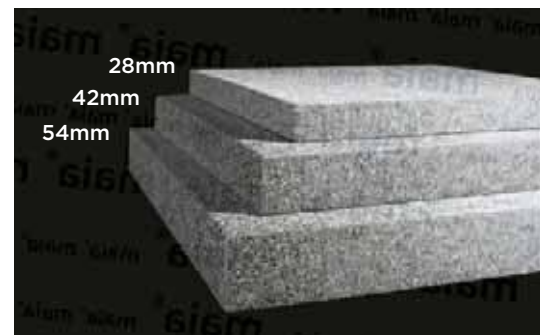

accessories

- Jointing kit (bolts, tongues, 75ml adhesive sachet and 3 grades of sandpaper and red abrasive pad to finish)
- 75ml sachet adhesive
- 250ml tube adhesive
- 250ml applicator gun
- Chopping board
- Additional edge strip (1200mm) 28mm, 42mm or 54mm
- Display stand
- Stainless steel finish worktop protector rods (pack of six)
- Installation, care and maintenance DVD
- maia Care Kit (Countertop cleaner, ergonomic foam sanding block, microfibre cloth, 2 x 320 grit sandpaper, 2 x red abrasive pad)

worktops

(square corners)

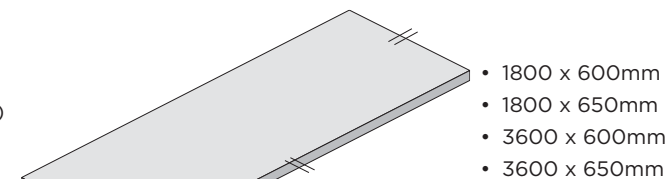

- 1800 x 600mm
- 1800 x 650mm
- 3600 x 600mm
- 3600 x 650mm

worktops

(240mm radius)

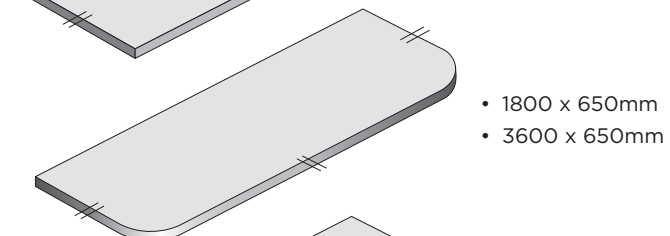

- 1800 x 650mm
- 3600 x 650mm

breakfast bars

(square corners)

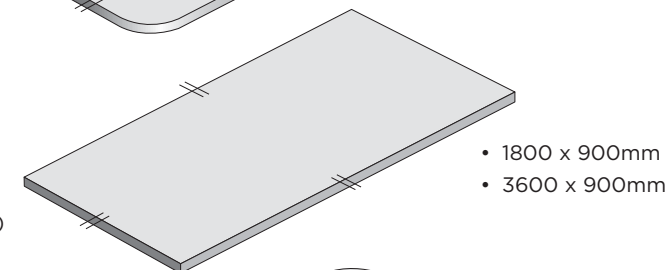

- 1800 x 900mm
- 3600 x 900mm

breakfast bars

(240mm radius)

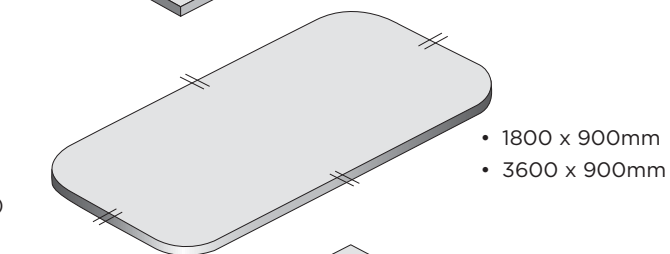

- 1800 x 900mm
- 3600 x 900mm

island

(square corners)

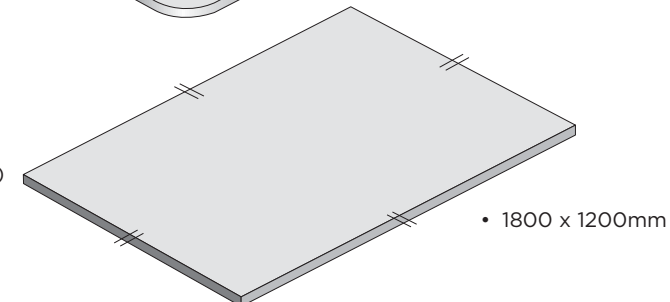

- 1800 x 1200mm

island

(240mm radius)

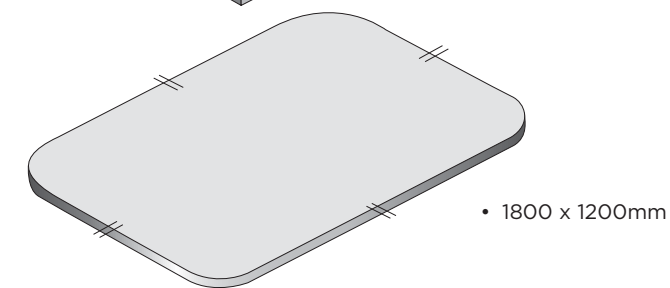

- 1800 x 1200mm

1.8m sink modules

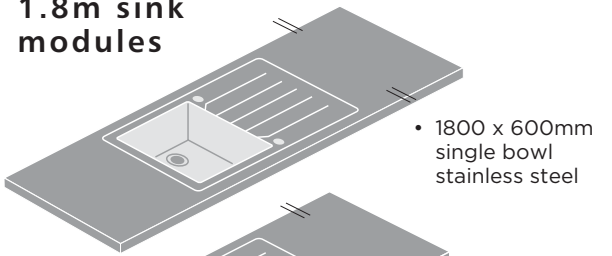

- 1800 x 600mm single bowl stainless steel

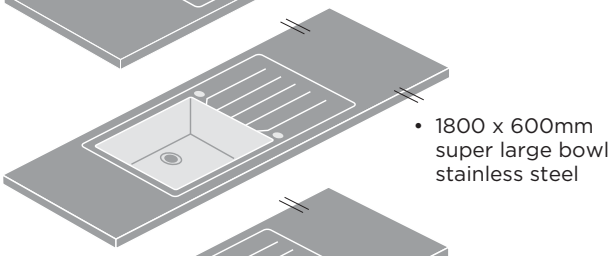

- 1800 x 600mm super large bowl stainless steel

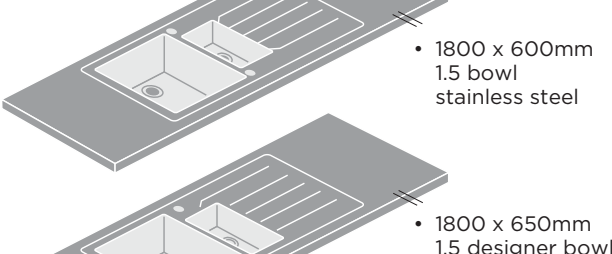

- 1800 x 600mm 1.5 bowl stainless steel

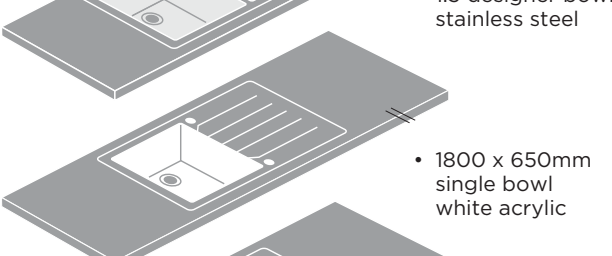

- 1800 x 650mm 1.5 designer bowl stainless steel

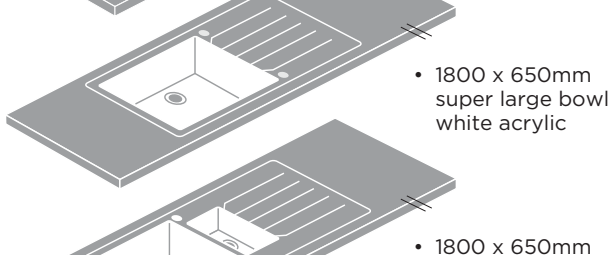

- 1800 x 650mm single bowl white acrylic

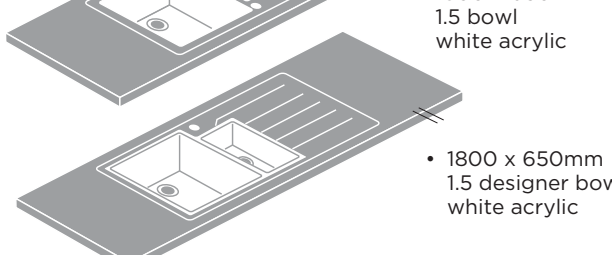

- 1800 x 650mm super large bowl white acrylic



- 1800 x 650mm 1.5 bowl white acrylic

- 1800 x 650mm 1.5 designer bowl white acrylic

3.6m sink modules

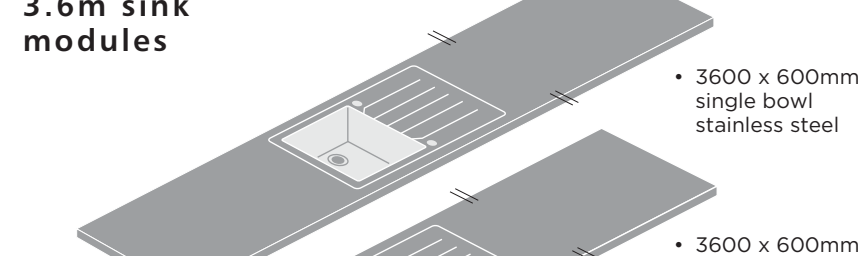

- 3600 x 600mm single bowl stainless steel

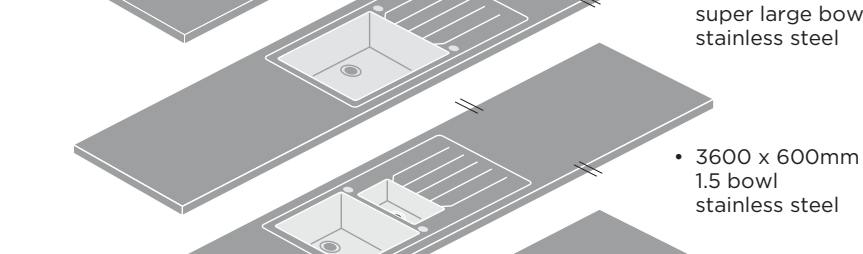

- 3600 x 600mm super large bowl stainless steel

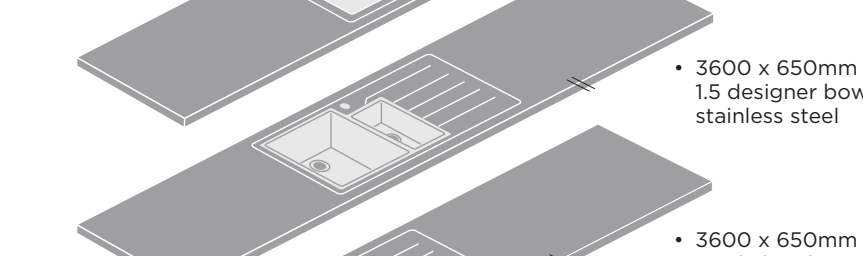

- 3600 x 600mm 1.5 bowl stainless steel

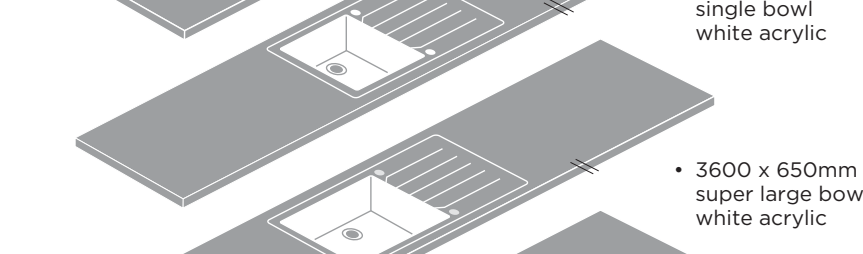

- 3600 x 650mm 1.5 designer bowl stainless steel

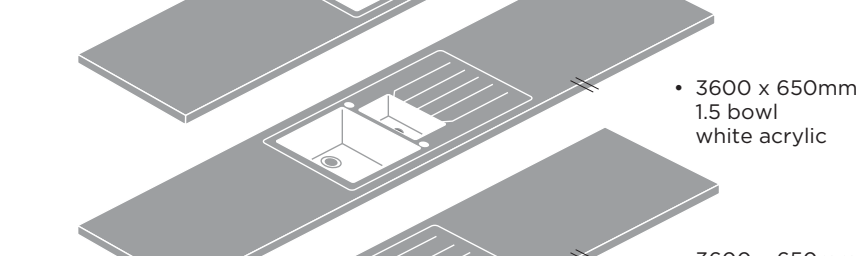

- 3600 x 650mm single bowl white acrylic

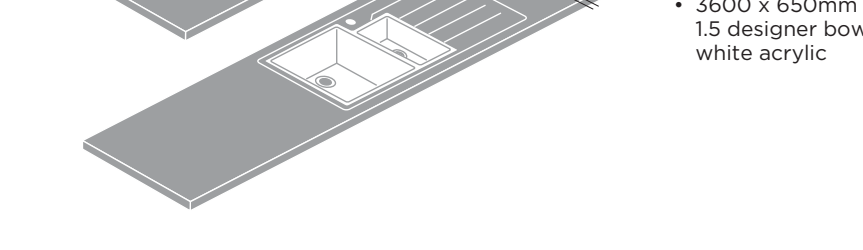

- 3600 x 650mm super large bowl white acrylic

- 3600 x 650mm 1.5 bowl white acrylic

- 3600 x 650mm 1.5 designer bowl white acrylic

accessories

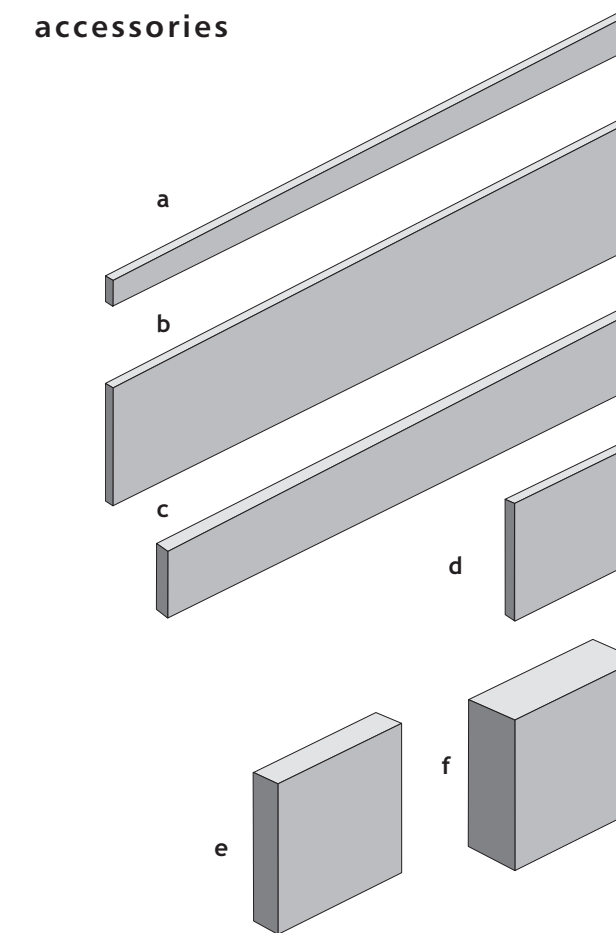

a. upstand

- 3680 x 70 x 10mm
- 3680 x 150 x 10mm

Solid acrylic sheet with profiled top edge. Surface finish as per worktops.

b. splashback

- 3680 x 580 x 10mm
- 1830 x 580 x 10mm

Solid acrylic sheet with profiled top edge. Surface finish as per worktops.

c. plinth

- 3600 x 150 x 15mm

Décor applied to moisture resistant MDF core.

d. hob splashback

- 900 x 760 x 10mm

Solid acrylic sheet with all edges square cut. Surface finish as per worktops.

e. decorative support panel

- 900 x 897 x 45mm

Décor applied to both large faces and leading edge. Additional edging supplied.

f. decorative support panel

- 900 x 897 x 100mm

Décor applied to both large faces and leading edge. Additional edging supplied.

taps

all maia* taps feature

- Polished chrome finish
- Flexi tails and non-return valve
- Suitable for low or high pressure systems (0.2 - 6.5 bar)



Contour

The elongated, smooth curves of this twin lever mixer make it a bold and fashionable choice. Fitted with flow aerator.



Curve

A twin lever mixer exuding understated style, this chrome finish tap is a simple and timeless option for all homes. Fitted with flow aerator.



Geometry

This single lever mixer has a square design which makes it the perfect choice for contemporary kitchens.



Mix

This twin lever mixer combines a stylish curved tap with square designed levers for those who wish to mix and match elegance with contemporary good looks. Fitted with flow aerator.



Flow

A bold and confident tap with a double lever, this mixer will deliver cutting edge looks to complement any hard working kitchen. Fitted with flow aerator.

If you like our
kitchen worksurfaces please
visit our website
www.maiabathrooms.co.uk



maia[®]
10 Year Guarantee

Sylmar Technology Limited Azalea Close Clover Nook Industrial Park Alfreton Derbyshire DE55 4QX
T 01773 521300 F 01773 836837 W www.maiaworksurfaces.co.uk E sales@sylmar.co.uk



maia[®] is a registered trademark of Sylmar Technology Limited. Copyright © Sylmar Technology Limited 2015

Disclaimer: Colours are as accurate as the printing process allows. As part of a process of on-going innovation, we reserve the right to change specifications without prior notice.